



D300-BLD BLDC Motor driver

Product features

Parameters	Min Value	Typical Value	Max Value	Unit
Power supply	12	48	56	VDC
Output current	-	-	15	A
Over voltage protection	-	-	5	V
Under voltage protection	12	-	-	mA
External potentiometer	-	10K	-	Ω
Input analog voltage	-	-	5	VDC
Speed control range	-	-	20000	RPM

*Limited by the maximum rated speed of the motor

Functions setting

Motor pole pair selection

In order to match different motors, customers have choices for pole pair selection via SW1.
SW1=OFF, 4 pole pairs (default)
SW1=ON, 2 pole pairs

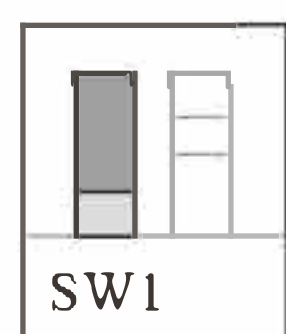

PID closed loop selection

In order to improve the stability of speed when in variable load application environment, customers are advised to select closed loop mode via SW2.
SW2=OFF, open loop (default); SW2=ON, closed loop.

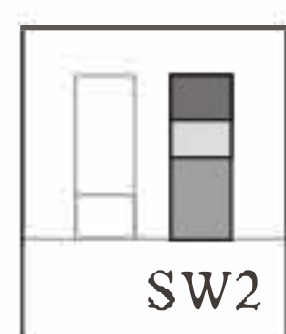

Max output current setting

P-sv current setting is for protecting the driver when it runs under over-load condition via over-current alarm. The set current value should be matched with the rated current of the matched motor and real voltage used. The set range: 3A-15A.

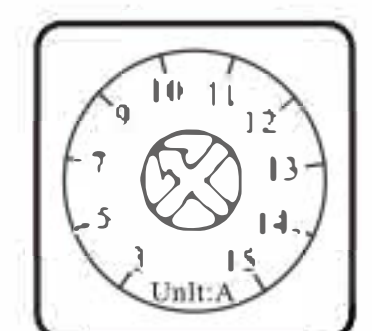

P-sv Current

Acceleration and deceleration settings

This potentiometer can be used for adjusting acceleration and deceleration time directly. Acceleration is the time the motor needs from stationary state to rated speed state; Deceleration time is the time the motor needs from rated speed state to stationary state. The range can be set is: 0.3s-15s.

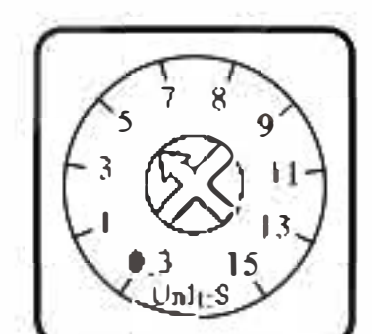

ACC/DEC

Machine dimension

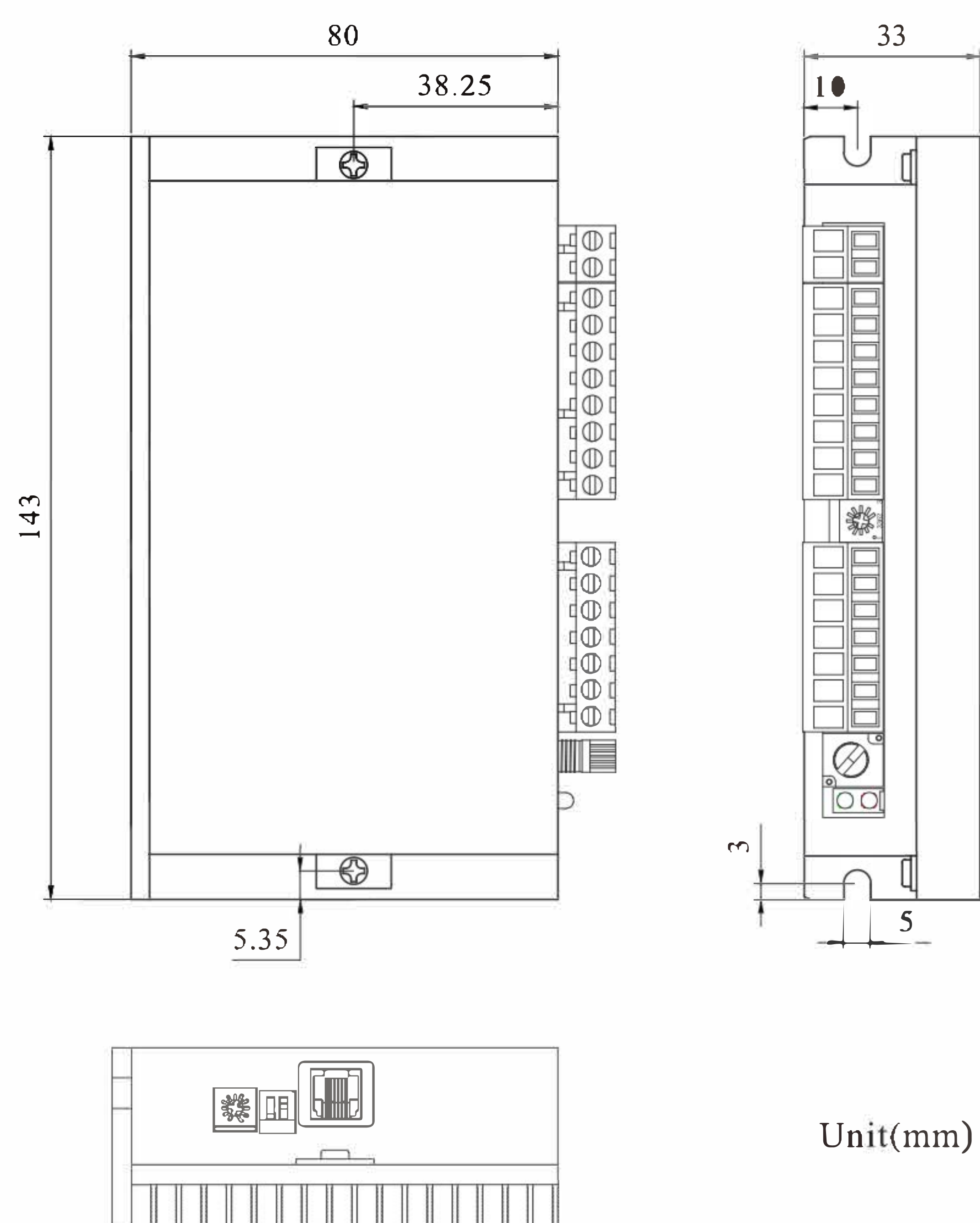

Unit(mm)

Port signal description

CN5Terminal	Signal category	Functional Description
DC+	Power connection	Power supply positive electrode (12-30VDC)
DC-		Power supply negative electrode (Hall sensor negative electrode)
W	Motor connection	Motor line W phase
V		Motor line V phase
U		Motor line U phase
REF+	Hall signal	BLDC Hall signal power positive pole
HW		Hall sensor signal Hw
HV		Hall sensor signal Hv
HU		Hall sensor signal Hu
REF-		BLDC Hall signal power negative electrode
SV	Control signal	External speed setting signal input terminal; when connecting external potentiometer, the middle terminal connects SV, the other two terminals connect to REF and COM.
COM		Common port(0V)
F/R		Motor direction control terminal; F/R and COM disconnect, motor will rotate clockwise; otherwise, motor will rotate anticlockwise.
EN		Motor stop signal port; When EN and COM disconnect, motor stops slowly while when they are connected, motor runs.
BRK		Motor brake stop control signal; BRK and DC- connect in default, motor brake stops when BRK and DC- disconnect.
SPEED	Output signal	Speed signal output port. Pulse frequency is corresponding to the rotating speed
ALM		Alarm signal output port. When fault occurs, the voltage changes to 0V from 5V.

Driver interface and wiring diagram

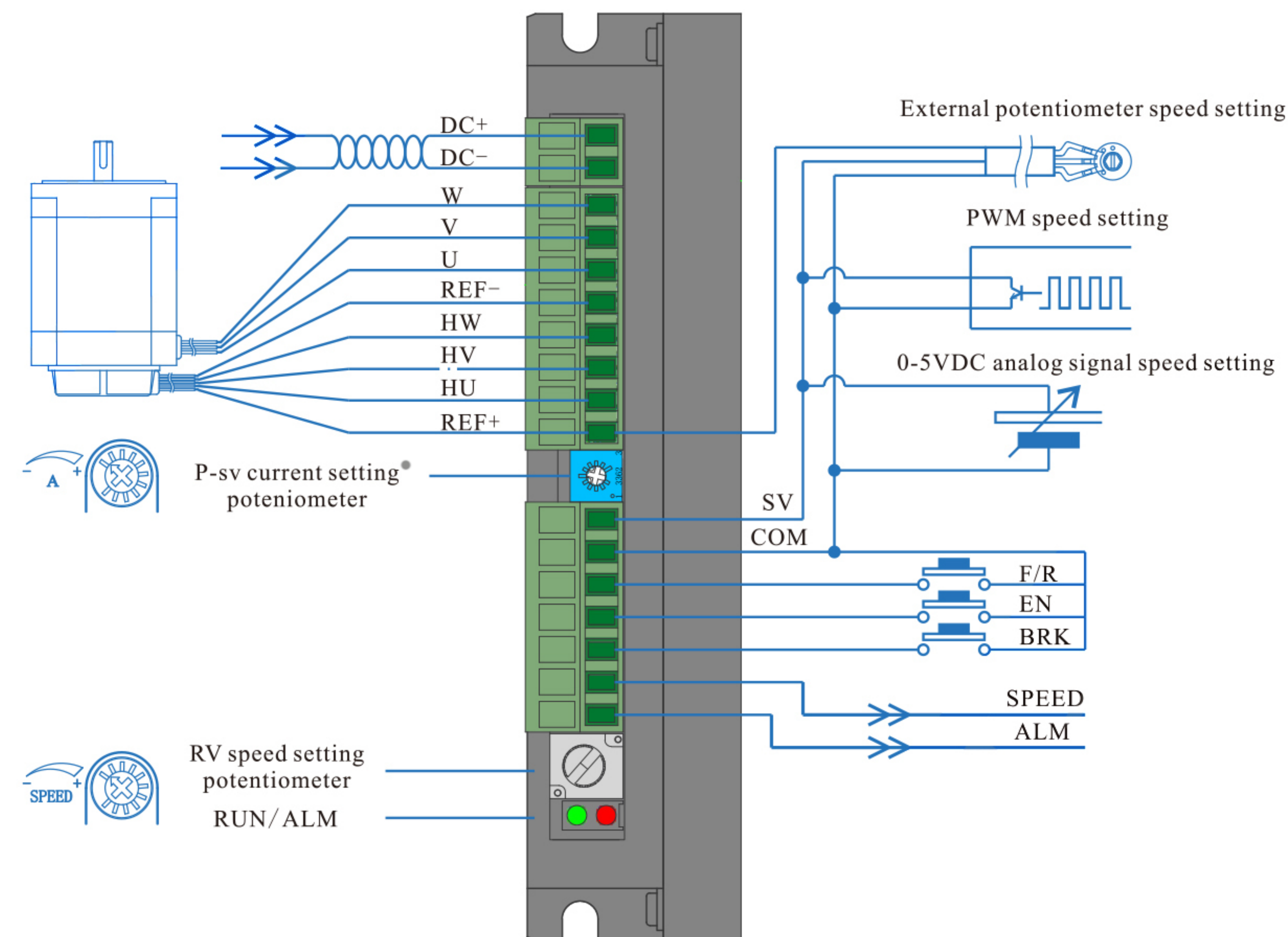

Speed setting via built-in potentiometer

Motor speed increases when RV knobs is rotated clockwise, when anticlockwise, motor speed decreases. If customers use others speed setting modes, RV should be rotated anticlockwise to limit position.

Built-in potentiometer RV

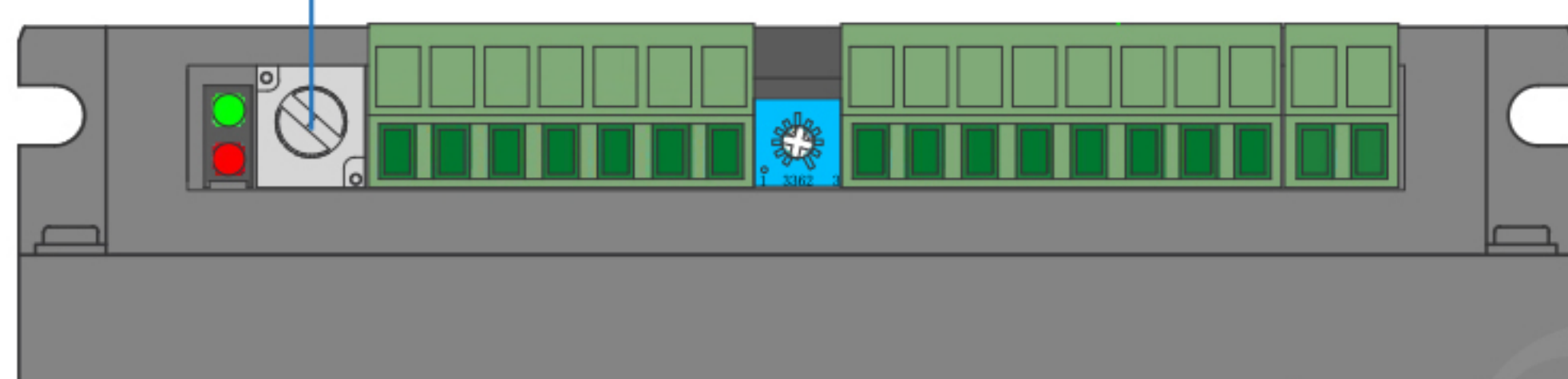

Speed setting via external potentiometer

Use a suitable potentiometer with a resistance value of 10K Ω ; when connect external potentiometer, the middle terminal connects to SV, the other two terminals connect to VCC and DC-.

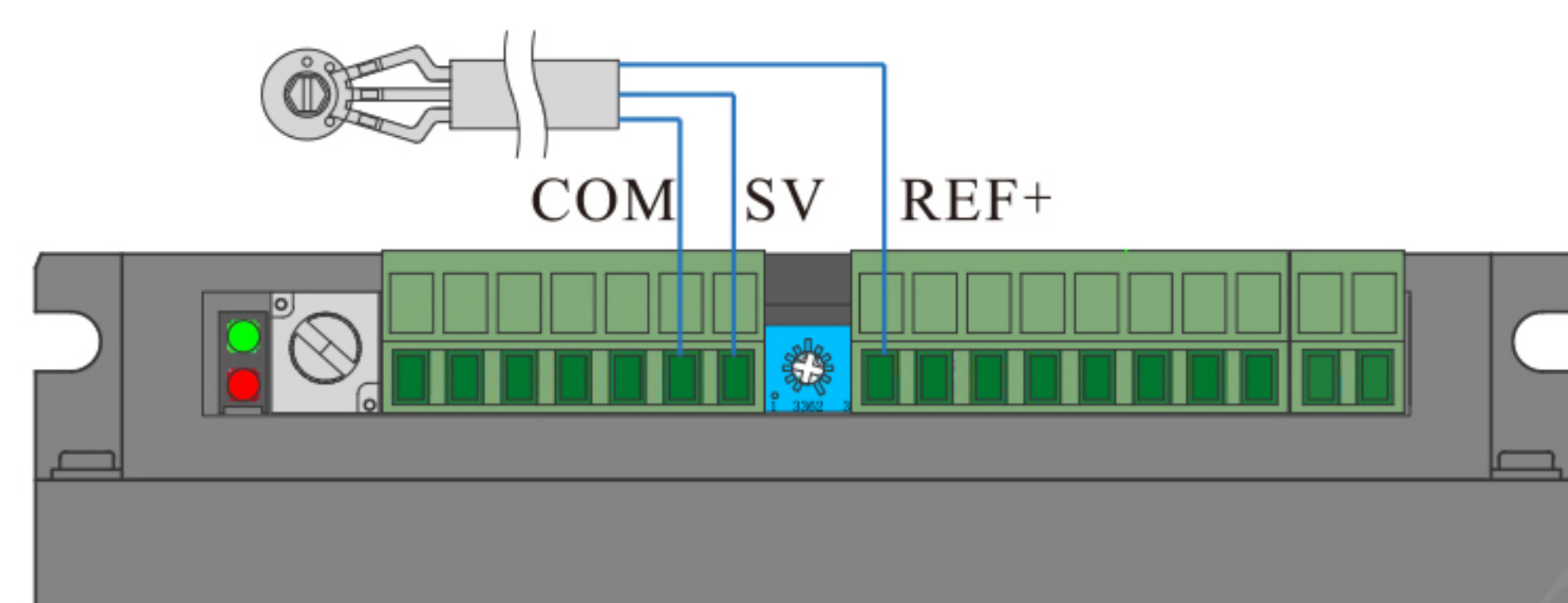

PWM speed setting mode

When customers select PWM speed setting mode, the duty ratio is advised to set as 2%-90%. When duty ratio is 2%, the motor speed reaches 5% of the fastest speed; when the duty ratio is 90%, the motor speed reaches maximum value, which depends on the motor specification and power voltage. (The pulse frequency range: 1-3KHz).

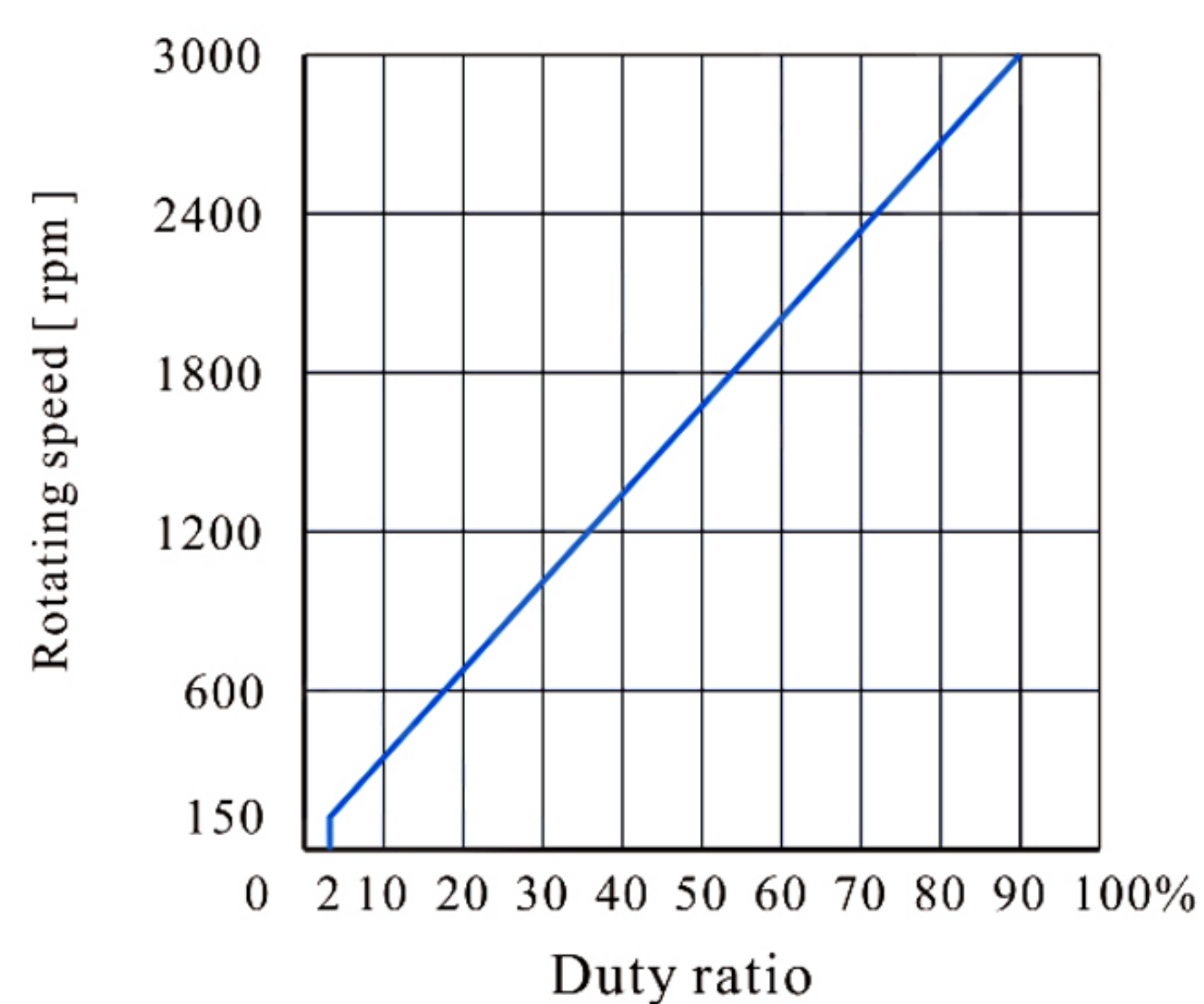

Speed setting via external analog signal

The analog signal voltage can be 0-5VDC; when the voltage is 0.25-VDC, the motor speed reaches 5% of fastest speed; when the voltage is 4.7VDC, the motor speed reaches maximum value, which depends on the motor specification and power voltage.

