

## Conductivity/Hardness/Resistivity Online Meter

User Manual







SKU: ATO-CDTYM-20

### Introduction

- Thank you for purchasing the conductivity/hardness/resistivity online meter. The operation manual gives a detailed description about various realizable functions, wiring methods, setup methods, operation methods and fault handling methods. Please read carefully the operation manual and understand the correct application methods before putting into operation, to avoid unnecessary losses due to operation mistakes. If the instrument is operated in other ways not described in the manual, the protections that the instrument give may be destroyed, and the failures and accidents incurred due to violation of precautions shall not be borne by our company.
- Please read the operation manual carefully before applying the instrument. On the precondition of full understanding, the instrument shall be installed, operated and maintained by professional electrical personnel at site. Wrong installation or operation may lead to destruction of instrument or personal injury.
- The company promises to the user that, the hardware and accessories provided with the instrument during delivery shall not have any defects in materials and manufacturing process. Calculated from the day of purchase of the instrument, if the user informs of any defect on the product in the guaranty period, the company provides free maintenance or replacement unconditionally for the defect product. The company guarantees to provide lifelong maintenance for all the products.
- Following the principle of sustainable development, the company shall reserve the rights of modifying the performance parameters in the operation manual and also the rights of amending or abolishing the operation manual, without prior notification. The company shall notify the user in advance if modification of some parameters of the instrument may lead to serious accident. For improved instrument, the company shall publish updated operation manual or improvement instruction. If the descriptions in the operation manual deviate from the material object, the latter shall prevail.
- Any modification on the instrument is forbidden. Any accidents incurred due to unauthorized modification shall not be borne by the company.

## Indication of Signs in the Operation Manual

Sign	Name	Meaning
	DANGER	Serious personal injury, instrument destruction, great property losses or other accidents will be the consequence if no appropriate preventive
	ALERT	Pay special attention to the important information linked to product or particular part
	WARNING	Operate with cautious. Any operation mistake
	ATTENTION	Read carefully the annotation, which will provide substantial help to correct operation of

### DANGER

- Do not use the instrument in a flammable and combustible or steam area.
- The instrument can work in general cases. If the failure of the instrument may result in major accident or destroy other equipment, emergency stop electric circuit and protection loop should be set up.
- Confirm if the supply voltage is in consistent with the rated voltage before operation.
- To prevent from electric shock, operation mistake, abnormal display or big deviation in measurement, a good grounding protection must be made.
- Thunder prevention engineering facilities must be well managed: the shared grounding network shall be grounded at iso-electric level, shielded, wires shall be located rationally, SPD surge protector shall be applied properly.
- Some inner parts may carry high voltage. Do not open the square panel in the front except our company personnel or maintenance personnel acknowledged by our company, to avoid electric shock.
- Cut off electric powers before making any checks, to avoid electric shock.
- Check terminal screws and installation conditions on a regular basis. If it's loose, tighten it and then apply it.
- Unauthorized dismantling, processing, modification or repair of instrument can never be allowed. Otherwise, the instrument may move abnormally, or electric shock or fire accidents may be caused.

- Use dry cotton to wipe the instrument, instead of alcohol, gasoline or other organic solvent. Prevent any liquid from splashing onto the instrument. If the instrument falls into water, cut off power immediately, to avoid electric leakage, electric shock and fire accidents.
- Check grounding protection and fuse conditions on a regular basis. Do not run the equipment if grounding protection and fuse are not well equipped.
- The ventilation hole on the instrument casing must be kept unclogged, to avoid failure, abnormal movement, short lifetime and fire accident due to high temperature.
- Operate in strict accordance with the operation manual, otherwise, it's possible to damage the protection device of the instrument.



### ALERT

- Do not use the instrument if it is found damaged or deformed at opening of package.
- Prevent dust, wire end, iron fines or other objects from entering the instrument during installation, otherwise, it will cause abnormal movement or failure.
- During operation, to modify configuration, signal output, startup, stop, operation safety shall be fully considered. Operation mistakes may lead to failure and even destruction of the instrument and controlled equipment.
- Each part of the instrument has a certain lifetime, which must be maintained and repaired on a regular basis for long-time use.
- The product shall be scrapped as industrial wastes, to prevent environment pollution.

## User instruction

Please respect the operation procedures and precautions in the operation manual to use the product.

The instrument can work in general cases. If the failure of the instrument may result in major accident or destroy other equipment, emergency stop electric circuit and protection loop should be set up.

- The quality guaranty period of electrode of conductivity is one year, for the sake of more accurate measurement. After one year upon ex-work, the performance will be influenced whether to be further used. Then it should be replaced in time.
- Power on the instrument before calibration to preheat for over half an hour.
- During measurement, clean the instrument in distilled water (or demonized water) and dry with filter paper, to avoid inclusions in the test liquid.
- Contact the manufacturer in case of anomaly or damage of the instrument. Do not repair it at your own.

## Contents

Introduction .....	1
Indication of Signs in the Operation Manual .....	2
User Instruction .....	3
Contents.....	4
Section I Product Introduction.....	5
Characteristics .....	5
Technical Indicators .....	5
Section II Fixation & Installation.....	6
Installation of Instrument .....	7
Installation of Electrode .....	7
Wiring of Instrument.....	9
Section III Push-button Operation.....	11
Section IV HMI and Operation .....	12
Section V Setting.....	15
System Setting.....	15
Signal Setting .....	15
Online Calibration .....	16
Remote Setting .....	17
Alarm Setting .....	17
Information Inquiry .....	18
Section VI Communication .....	19
Section VII Failure Analysis & Trouble-shooting.....	21

## Section I Production Introduction

Conductivity/Hardness/Resistivity Online meter, an intelligent Online chemical meter, is widely applied for continuous monitoring and measurement of EC value or TDS value or ER value and temperature in the solution in the industry of thermal power, chemical fertilizer, environmental protection, metallurgy, pharmacy, biochemistry, food and water, etc.

Continuous monitoring measurement data is connected with the recorder via transmitting output to realize remote monitoring and recording. It can also be connected with RS485 portal via MODBUS-RTU protocol to access computer for monitoring and recording.

### Characteristics

- Dimensions: 98 \* 98 \* 132mm
- Implementation of standards: JB/T 6855-1993
- 2.4 inches 12864 lattice screen.
- Isolating transmitting output, with little interference.
- Isolating RS485 communication.
- EC/TDS/ER measurement, temperature measurement, top/bottom limit control, transmitting output, RS485 communication.
- Configurable manual and auto temperature offset function.
- Configurable upper/lower limit warning and delay.
- Configurable hummer and LCD backlight switch.
- Addition of universal password.
- Industrial controlled door keep, to avoid instrument halted.

## Technical indicators

- Configurable isolating transmitting 4-20mA output, max.loop750Ω, 0.1%FS.
- Conventional range controller Measuring range:
- 0.01 electrode: 1.00~20.00us/cm or 0.00~20.00mΩ
- \*cm 0.1 electrode: 1.0~200.0us/cm
- 1.0 electrode: 2~2000us/cm
- 10.0 electrode: 0.02~20ms/cm
- 30.0 electrode: 0.06~60ms/cm
- Large range controller Measuring range:
- 0.01 electrode: 1.0~200.0us/cm
- 0.1 electrode: 2.0~2000us/cm
- 1.0 electrode: 0.02~20ms/cm
- 10.0 electrode: 0.2~200ms/cm
- 30.0 electrode: 0.6~600ms/cm
- Accuracy: ±1%FS Stability: ±1%FS/24H
- Temperature measuring range:-10-130°C, accuracy: ±0.5°C, NTC10K or PT1000 temperature offset
- RS485 function: compactable with standard MODBUS-RTU communication protocol
- Supply power:AC220V ± 10%,50Hz/60Hz
- Warning relay:AC250V,3A

---

## Section II Fixation & Installation

### Installation of Instrument

Please read the instruction of installation location and method of instrument as described during installation.

### Installation precautions

The instrument serves mainly for detection and transmission, not dedicated for control. It is equipped with a relay switch output, for warning and reminding use generally. If the user involves the function in participating loop control, the failure of the instrument may lead to major accident or destruction of other equipment, emergency stop electric circuit and protection loop should be set up. Otherwise, the company will not be liable for any consequences incurred.

The instrument is panel-mounted and should be installed indoor, sheltered from wind, rain and direct sunlight. To avoid rise of temperature inside the instrument, it should be installed at a well-ventilated place. Do not tilt it during installation and try to locate it horizontally (tilting back <math><30^\circ</math>).

### Installation should be kept away from the following site

In direct exposure to sunlight and near thermal equipment. With ambient temperature over 60 degrees in operation.

With humidity over 85% in operation. Nearby electromagnetic source.

In strong mechanical vibration.

With varying temperature and dew condensation.

With oil smoke, steam, humidity, dust and corrosive gases.



## Installation methods

Open a 92.5 \* 92.5 installation hole on the instrument cabinet or installation panel. Insert the fixation screws into the hole, as shown below.

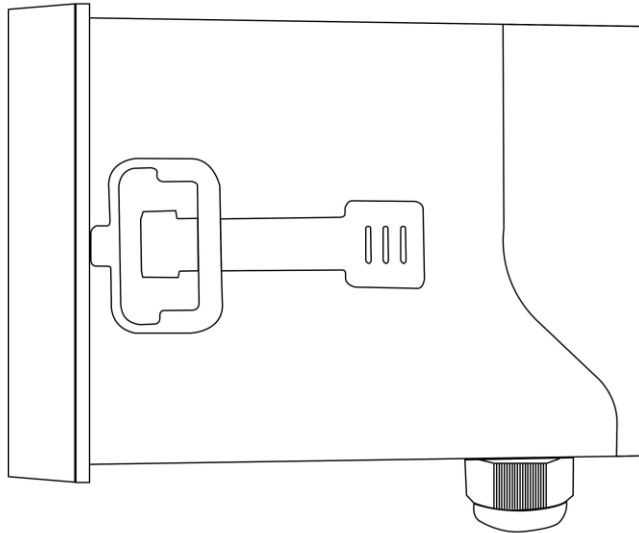

## Installation of Electrode

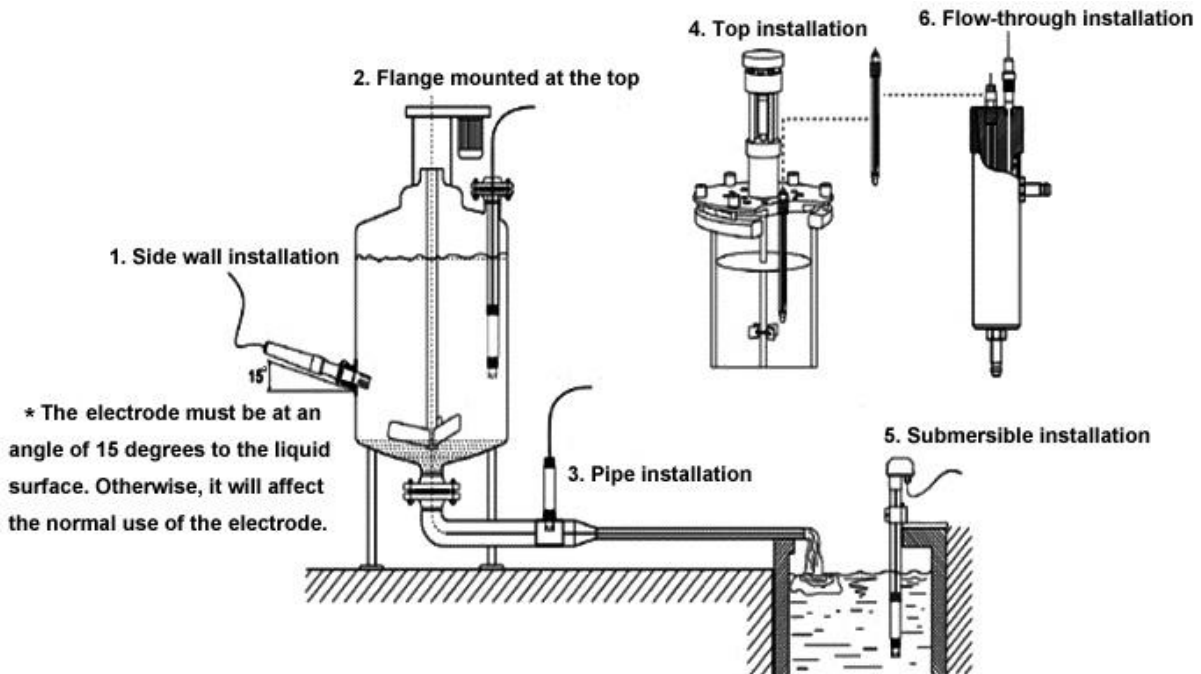

①Side wall installation ②Flange mounted at the top ③Pipe installation

④Top installation on ⑤Submersible installation ⑥Flow-through installation

The interface must be in 15° oblique angle, or it will affect the normal test and use of the electrode. We won't be responsible for any results due to this.

## Wiring of Instrument

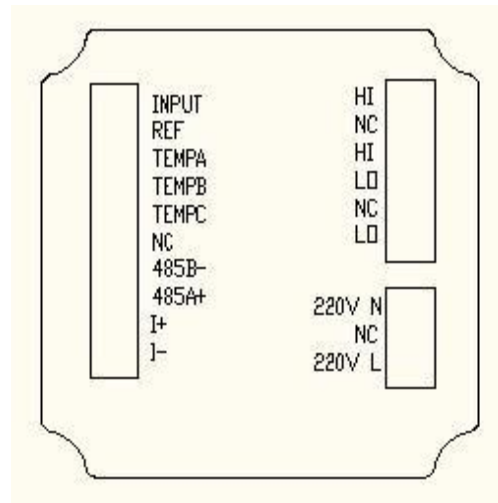

Wiring diagram

### Identification of terminal

- INPUT: Measuring terminal of electrode conductivity
- REF: Reference junction of electrode conductivity
- TEMP A: Temperature compensation terminal A, NTC10K and PT1000 connect here
- TEMP B: Temperature compensation terminal B, NTC10K and PT1000 connect here
- TEMP C: Temperature compensation terminal C, PT1000 three-wire temperature grounding, PT1000 two-wire need to be short-connected to TEMP B, not NTC10K.
- NC: Unidentified
- RS485(A+): RS485 communication interface A+
- RS485(B-): RS485 communication interface B-
- I(+): 4-20mA output end+
- I(-): 4-20mA output end-
- AC220V(L) or (DC24V-): AC220V fire wire or (DC24V cathode)

special type)

- AC220V(N)or (DC24V+):AC220V fire wire or (DC24V anode

special type)

- LO(AL): low relay
- HI(AH): high relay

### Notes:





- Confirm that the instrument is not power on before connected with signal wire, to avoid electric shock.
- Use double insulation wire to prevent fire accident.
- Do not put electric product close to signal terminal, which may cause failure.
- The instrument can automatically switch the conductivity measurement range. During the process, it will wait for a few seconds to prevent abnormal alarm caused by range switch.
- Large range conductivity has no resistance measurement function.

## Section III Push-button Operation

### Button display



### Definition of buttons

Sign	Button Name	Function description
	MENU	Enter the MENU on the “monitoring page” Exit the MENU on the “menu page”
	EXIT	Check related warning status on the “monitoring page” Return to previous level page in the up& down level page linked to “menu page”
	MOVE RIGHT	Make a recurrent selection of digit of parameters Remove the original indication value in the “conductivity calibration page”
	MOVE DOWN	Select the related menu on the “menu page” Modify the values in the configuration state
	ENTER	Enter the sub-menu or confirm modification on the “menu page”

## Section IV HMI and Operation

### Monitoring page

The instrument is equipped with monochrome lattice LCD, 128\*64 resolution.

Push [MENU] to enter password verification page; input password to enter the home page.

Push [EXIT] to enter alarm inquiry page, to inquire the current warning configuration information.

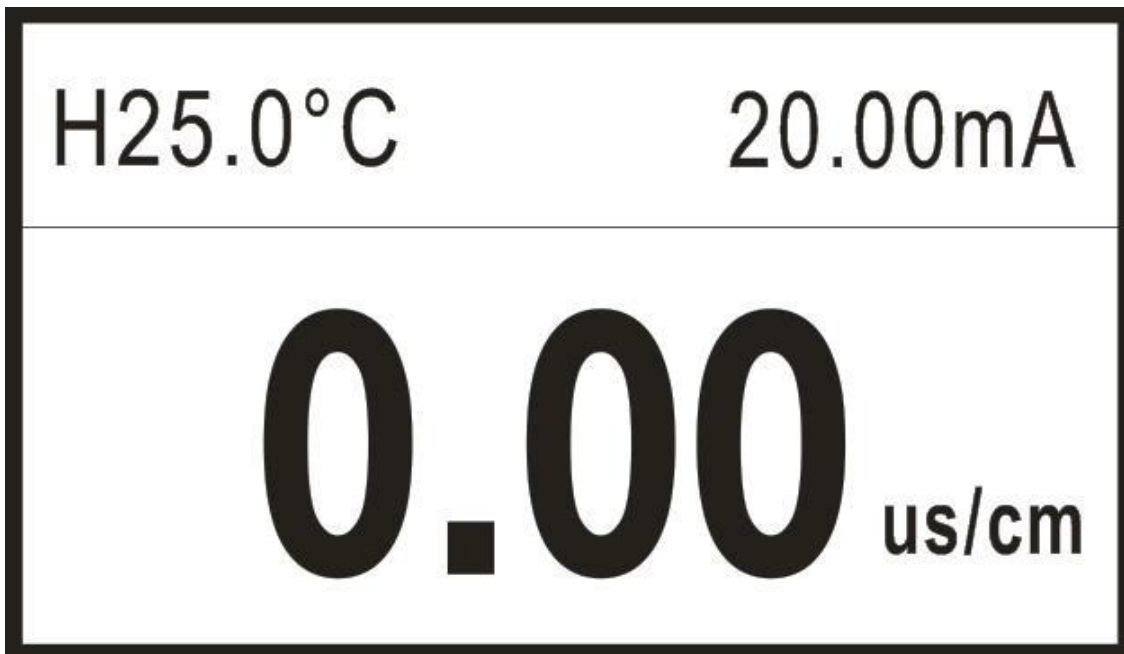

EC monitoring page

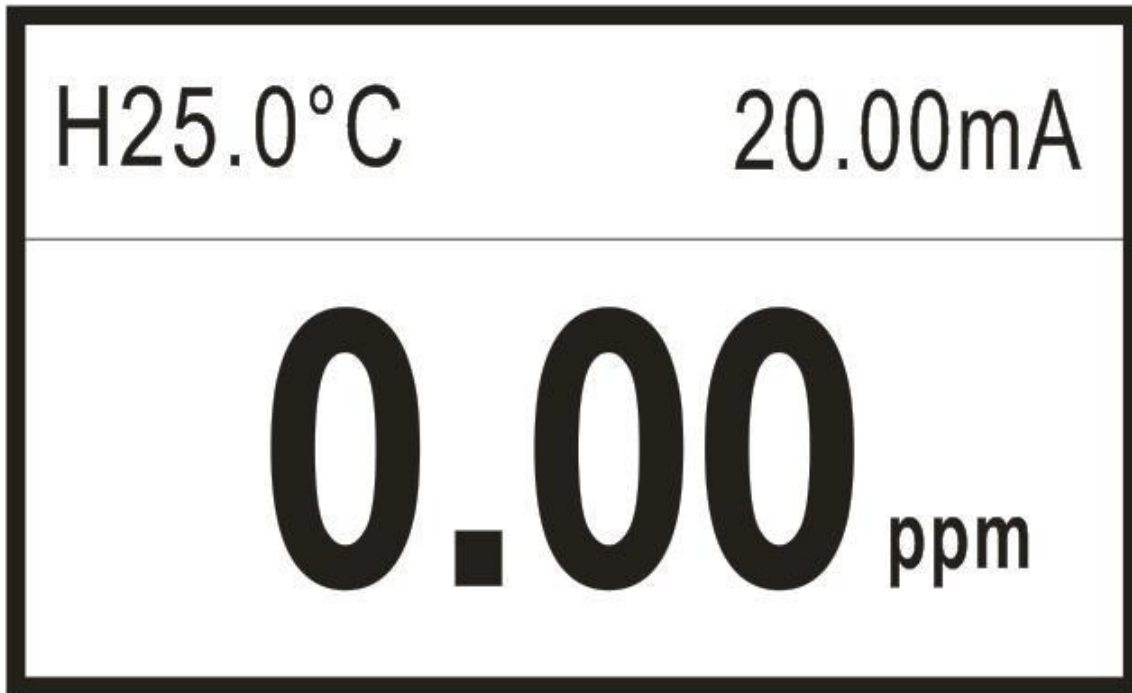

TDS monitoring page

## Password verification page

Input password and push [CONFIRM] to enter home page.

Initial password is 0000, which can be modified via password modification function. Please contact us if you forget your password.

-----User Password-----

Password: 0000

## Main Menu

- Main Menu -----
- ➡ 1. System Setting
  - 2. Signal Setting
  - 3. Online Calibration
  - 4. Remote Setting
  - 5. Alarm Setting
  - 6. Information Inquiry

- a) System Setting: settings of language, buzzer and backlight, modification of password and factory settings.
- b) Signal Setting: constant of electrode, TDS factors and temperature offset factor settings, unit switch and temperature offset switch.
- c) Online Calibration: correction of temperature and calibration of conductivity signal.
- d) Remote Setting: settings of RS485 parameters and current transmission output.
- e) Alarm Setting: settings of parameters of high and low warning.
- f) Information Inquiry: current version number.

## Section V Setting

### System Setting

#### ----- System Setting -----

- ➡ 1. Language
- 2. Buzzer
- 3. Backlight Setting
- 4. Change Password
- 5. Factory Setting

- a) Language: language type, Chinese or English.
- b) Buzzer: settings of switch of buzzer during warning.
- c) Backlight setting: settings of LCD backlight.
- d) Password modification: password modification and log-in with new password.
- e) Factory setting: return to factory settings

### Signal Setting

#### ----- Signal Setting -----

- ➡ 1. Electrode Constant
- 2. Unit Switch
- 3. TDS Coefficient
- 4. Temp Switch
- 5. Temp Coefficient



Electrode constant: electrode constant. Normally of 4 types: 0.01, 0.1, 1.0, 10.0

Unit switch: conversion unit, ppm or us/cm or  $m\Omega \cdot cm$ , hardness of solution (TDS) for ppm and conductivity (EC) of solution for us/cm. When it is switched to  $m\Omega \cdot cm$ , the electrical resistivity (ER) of the solution is measured.

TDS Coefficient: conversion coefficient of conductivity and hardness, 0.5 as default.

Temp Switch: auto temperature offset NTC10K or PT1000 or manual temperature compensation, temperature range:  $-10^{\circ}C$ - $130.0^{\circ}C$ .

Temp Coefficient: temperature compensation coefficient, 0.02 as default.

### Online Calibration

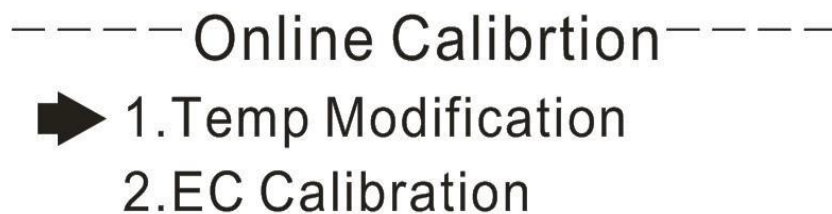

Temp Modification: correction of auto temperature compensation value, in a range of  $\pm 20.0^{\circ}C$ .

EC calibration: It is able to make single-point calibration of any standard solution.

Set the temperature compensation method as automatic or manual compensation (calibration temperature has a big impact on the accuracy during calibration). Enter the conductivity calibration input interface. Input the value of standard solution for calibration and press the **【Confirm】** key to enter the conductivity calibration interface. Put the well-connected electrode into the standard solution. Wait until the

indication is stable. Then press **【OK】** key to calibrate. (Press **【Right Shift】** key to clear the calibration value; the calibration range is the standard solution value 0.5-1.5.)

## Remote Transmission Setting

----- Remote Setting -----  
➡ 1. RS485 Setting  
    2. Current Transmission

- a) RS485 setting: settings of 485 communication address and baud rate.
- b) Current transmission: settings of 4mA corresponding value and 20mA corresponding value of 4-20mA output.

## Alarm Setting

----- Alarm Setting -----  
➡ 1. EC High Alarm  
    2. EC Low Alarm  
    3. TDS High Alarm  
    4. TDS Low Alarm  
    5. ER High Alarm  
    6. ER Low Alarm

EC high alarm: when the measured value is higher than high alarm pull-on value, high alarm relay pulls on; when the measured value is lower than high alarm cut-off

value, high alarm relay cuts off.

EC low alarm: when the measured value is lower than low alarm pull-on value, low alarm relay pulls on; when the measured value is higher than lower alarm cut-off value, low alarm relay cuts off.

TDS high alarm: when the measured value is higher than high alarm pull-on value, high alarm relay pulls on; when the measured value is lower than high alarm cut-off value, high alarm relay cuts off.

TDS low alarm: when the measured value is lower than low alarm pull-on value, low alarm relay pulls on; when the measured value is higher than lower alarm cut-off value, low alarm relay cuts off.

ER high alarm: when the measured value is higher than high alarm pull-on value, high alarm relay pulls on; when the measured value is lower than high alarm cut-off value, high alarm relay cuts off.

ER low alarm: when the measured value is lower than low alarm pull-on value, low alarm relay pulls on; when the measured value is higher than lower alarm cut-off value, low alarm relay cuts off.

## **Information Inquiry**

— — — — Information Inquiry — — — —

Information inquiry: inquire the current hard software version, high traceability.

## Section VI Communication

The instrument is provided with standard RS485 series communication interface, in accordance with international universal standard MODBUS-RTU communication protocol, supporting No.03 register reading and holding command.

### MODBUS standard format (No.03 register reading and holding command)

#### Command format:

Definition	Address	Function code	Register address	Number of data	CRC check
Data	ADDR	0x03	M	N	CRC16
Number of bytes	1	1	2	2	2

#### Return format:

Definition	Address	Function code	Data size	Data	CRC check
Data	ADDR	0x03	2*N	Data	CRC 16
Number of bytes	1	1	1	2*N	2

#### Register address description:

Address	Data type	Date size	Function code	Description	Access authority
0x0000	unsigned long	4 bytes	0x03	Conductivity value (unit: us/cm, to be divided by 100)	Read only
0x0002	short	2 bytes	0x03	Temperature value (unit: °C, to be divided by 100)	Read only
0x0003	unsigned long	4 bytes	0x03	TDS value (unit: ppm, to be divided by 100)	Read only
0x0005	unsigned long	4 bytes	0x03	Resistivity value (unit: mΩ *cm, to be divided by 100)	Read only

### Example of conductivity reading:

Computer sends: 00 03 00 00 00 02 C5 DA

Conductivity meter returns: 00 03 04 00 00 00 00 EA F3

Return command annotation: 00 is the address of slave, which can be configured in the instrument;  
3 is function code, reading and holding register;  
4 is the length of data of returned conductivity value, 4 bytes;  
00 00 00 00 is the returned conductivity value, 0.00us/cm, unit: us/cm. The value obtained shall be divided by 100 to get the current conductivity value. The range: 0.00-20000.00us/cm.  
EA F3 is the CRC16 check code, which is varying depending on different data;

### Example of temperature reading:

Computer sends: 00 03 00 02 00 01 24 1B

Conductivity meter returns: 00 03 02 00 FA 05 C7

Return command annotation: 00 is the address of slave, which can be configured in the instrument;  
03 is function code, reading and holding register;  
02 is the length of data of returned temperature value, 2 bytes;  
00 FA is the returned temperature value, 25.0°C,  
unit: °C. The value obtained shall be divided by 10 to get the current temperature value. The range:  
-10.0-130.0°C.  
05C7 is the CRC16 check code, which is varying depending on different data.

## Section VII Failure Analysis & Trouble-shooting

1. No display on controller?

A: Check if the power cable is correctly connected, power is on.

2. Number in display is jumping up and down?

A: Check if there is any interference equipment such as frequency converter is nearby. The instrument should be kept away from such interference equipment or protected with good shielding measures.

3. Conductivity instrument cannot be calibrated?

A: The standard solution is not mixed in a correct way or the electrode is damaged.

4. The instrument cannot measure accurately after calibration with a standard solution of conductivity of 1413us/cm?

A: Check if the standard solution is polluted. Replace the solution and calibrate again.

5. The response of number is slow?

A: If the electrode is covered by dirt, the response would be slow. Clean the pollutant in a corresponding method. A slow response is normal in winter.